

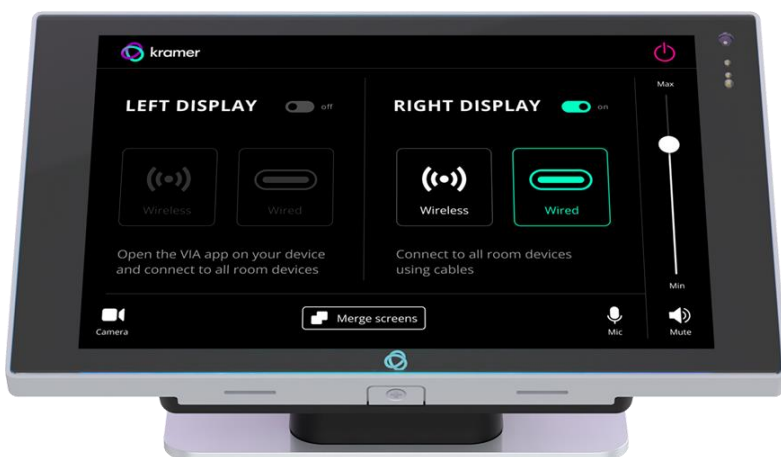

USER MANUAL

MODEL:

KT-208 / KT-208WM
8" Touch Panel



Contents

Contents	2
Introduction	3
Getting Started	3
Overview	5
Typical Applications	6
Defining KT-208 / KT-208WM 8" Touch Panel	7
KT-208 Tabletop Mount	8
KT-208WM On-Wall Mount	8
Mounting the KT-208 / KT-208WM	9
Mounting KT-208 on a Table	9
Mounting KT-208WM on a Wall	11
Connecting Options	12
Controlling KT-208 / KT-208WM	13
Using Navigation Buttons or Gestures	13
Using the Home Page	14
Exiting or Starting the Kramer Control agent	14
Basic Settings of KT-208 / KT-208WM	15
Essential First Steps	15
Setting the Date and Time	15
Connecting to Wi-Fi or Ethernet	16
Installing an 802.1X Certificate	17
Changing the Automated Firmware Update	18
Changing the Automated Kramer Control update	20
Setting the Display and Keyboard Language	21
Using the Kramer Control agent (connecting to Brain)	22
Entering the Control Interface IP & Port Number	22
The Kramer Control Agent Settings	23
Using the Kramer Control Agent's API	25
Methods of Setting the Control Interface URL	27
Advanced Settings	31
Scheduling a Daily Reboot	31
Password Protecting Device Settings	31
Factory Reset & Reboot	32
Logging Activity	32
Modifying Display Settings	33
Defining an auto-start playlist	33
Switching to Native Android Mode	34
Technical Specifications	35

Introduction

Welcome to Kramer Electronics! Since 1981, Kramer Electronics has been providing a world of unique, creative, and affordable solutions to the vast range of problems that confront the video, audio, presentation, and broadcasting professional on a daily basis. In recent years, we have redesigned and upgraded most of our line, making the best even better!

Getting Started

We recommend that you:

- Unpack the equipment carefully and save the original box and packaging materials for possible future shipment.
- Review the contents of this user manual.



Go to www.kramerav.com/downloads/KT-208 to check for up-to-date user manuals, application programs, and to check if firmware upgrades are available (where appropriate).

Achieving Best Performance

- Use only good quality connection cables (we recommend Kramer high-performance, high-resolution cables) to avoid interference, deterioration in signal quality due to poor matching, and elevated noise levels (often associated with low quality cables).
- Do not secure the cables in tight bundles or roll the slack into tight coils.
- Avoid interference from neighboring electrical appliances that may adversely influence signal quality.
- Position your Kramer **KT-208 / KT-208WM** away from moisture, excessive sunlight and dust.

Recycling Kramer Products

The Waste Electrical and Electronic Equipment (WEEE) Directive 2002/96/EC aims to reduce the amount of WEEE sent for disposal to landfill or incineration by requiring it to be collected and recycled. To comply with the WEEE Directive, Kramer Electronics has made arrangements with the European Advanced Recycling Network (EARN) and will cover any costs of treatment, recycling and recovery of waste Kramer Electronics branded equipment on arrival at the EARN facility. For details of Kramer's recycling arrangements in your particular country go to our recycling pages at www.kramerav.com/quality/environment.

Safety Instructions

This unit is intended to be supplied by:

- UL / IEC 62368-1 certified PoE output power supply suitable for use at an ambient temperature of 40°C and an altitude of 2,000 m whose output meets ES1, and is rated 44-57 V DC, minimum 0.3 A.
- UL / IEC 62368-1 certified Class II power adapter suitable for use at an ambient temperature of 40°C and an altitude of 2,000 m whose output meets ES1, and is rated 12 V DC, minimum 1.0 A.



Caution:

- This equipment is to be used only inside a building. It may only be connected to other equipment that is installed inside a building.
- For products with relay terminals and GPIO ports, please refer to the permitted rating for an external connection, located next to the terminal or in the User Manual.
- There are no operator serviceable parts inside the unit.
- Risk of explosion if the battery is replaced by an incorrect type. Wait one-half hour after switching off before handling parts.



Warning:

- If not using PoE, use only the optional power cord that is supplied for the unit.
- Do not open the unit. High voltages can cause electrical shock! Servicing by qualified personnel only.



Laser Safety:

- This product complies with FDA performance standards for laser products except for conformance with IEC 60825-1 Ed. 3., as described in Laser Notice No. 56, dated May 8, 2019.
- Date of manufacture: The date code at the bottom of the product label represents the manufacturing date of this laser product.



Caution: Invisible laser radiation when open. Avoid exposure to beam. Class 1 laser product. This system must be opened only by qualified technicians to prevent accidents caused by the laser beam.

Caution: Use of controls or adjustments or performance of procedures other than those specified herein may result in hazardous radiation exposure.

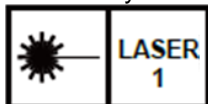

The ambient light sensor can automatically adjust panel brightness based on the environment. See Display Settings to enable automatic brightness.

The Laser proximity sensor will detect nearby motion to wake the panel up without requiring a touch.

Overview

Congratulations on purchasing your **Kramer KT-208 / KT-208WM 8" Touch Panel**.

KT-208 / KT-208WM is a new powerful, 8-inch, IPS, multi-touch, touch panel with 1280x720 resolution. Elegantly designed for decorative room integration, this portable touch panel can be deployed either on a tabletop or wall.

KT-208 / KT-208WM, with the latest Android 11, supports wired PoE (Power over Ethernet) and advanced Wi-Fi connectivity options. The touch panel has a built-in speaker and camera and comes either with a tabletop or a wall mount. The touch panel is easy to assemble, using elegant wiring, secured mounting, reliable operation and flexible deployment.

KT-208 / KT-208WM is a touch panel that is ideal for any 24/7 Kramer-supported commercial AV or control application and features a user-friendly, fully customizable graphical user interface configured by Kramer software.

Exceptional Quality

- **Elegant Design** – Smooth integration with room furniture, either on tables or walls, with flexible panel cabling and locking design options.
- **Superior User Experience** – IPS 1280x720 hi-resolution screen with $\pm 80^\circ$ horizontal and vertical wide viewing angles, built-in lighting sensor for auto-adaptable brightness, with advanced 10 multi-touch points and 2-finger gesture capabilities.
- **Powerful Processing** – i.MX8M Plus Quad Core A53, 4GB RAM, 32GB ROM processing performance, smoothly running complicated media and graphics-rich applications, such as H.265 video, audio streams encoding and decoding, and seamless hi-resolution 5Mp FF front camera operation.
- **Flexible Services** – Latest Android 11 operating system.

Advanced and User-friendly Operation

- **Easy Installation** — Powering and connectivity via a single Ethernet cable.
- **Flexible Mounting** — Including table and wall mounts.
- **Optional Connectivity** — Simple wireless Bluetooth 5 as well as connection to USB peripheral devices for either table or wall-mount installations, using the included USB cable.
- **Versatile Powering Options** – PoE and power adapter (sold separately).
- **Auto Sensing** — Optimized performance and operation according to automatically detected LAN speed.
- **Firmware Upgrade** — Define automatic updates on a predefined time of the day or update manually using USB port.

Security

- **Secured Operation** – Highly secured operation of applications using password protection, hidden control buttons and more. Red LED alert when camera is active.
- **Secured Deployment** – Flexible locking options to prevent unwanted panel-mount removal, elegantly designed to remain out of site.

Typical Applications

The KT-208 / KT-208WM is ideal for the following typical applications:

- Control user interface in meeting and conference rooms, boardrooms, and auditoriums.
- Presentation of room scheduling.

Defining KT-208 / KT-208WM 8" Touch Panel

This section defines KT-208 / KT-208WM.

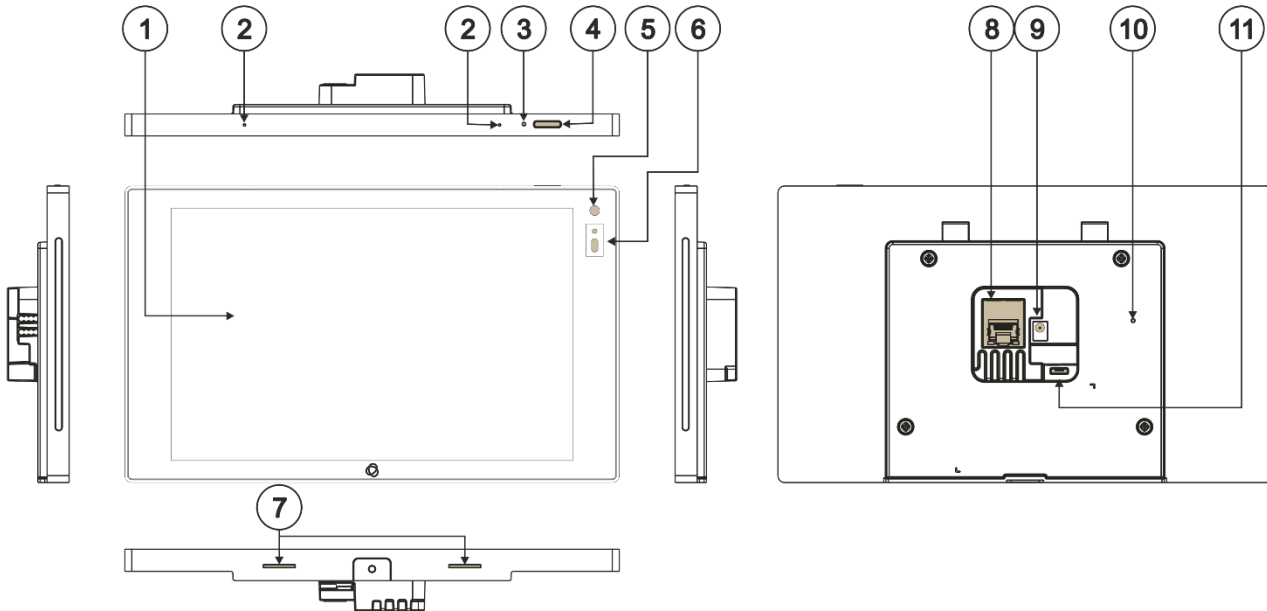

Figure 1: KT-208 / KT-208WM 8" Touch Panel

#	Feature	Function
①	Display	Touch panel
②	Microphone	For audio communication, recording or conferencing.
③	Recessed Restart Button	Located on the top-side. Insert a pin and hold for a few seconds to restart.
④	Home Button	Press to wake up / darken the screen.
⑤	Camera	For remote room viewing or video conferencing.
⑥	Light Sensor	Automatically adjusts the screen brightness and camera according to the room lighting conditions.
⑦	Speakers	To output the sound.
⑧	LAN 1G(PoE) RJ-45 Port	Connect to the LAN for network communication. KT-208 and KT-208WM are powered by PoE (power over ethernet) delivered through the LAN port. Optionally, you can connect the power adapter too (as backup).
⑨	12V/1A DC Connector	Connect to the power adapter (optional, purchased separately).
⑩	Restore Factory Reset Button	Insert a pin and hold for 22 seconds to reset the device to factory default values.
⑪	Micro USB Port	For connecting to an adjacent on-wall USB device and for firmware upgrade.

KT-208 Tabletop Mount

This section defines the KT-208 / KT-208WM tabletop mount.

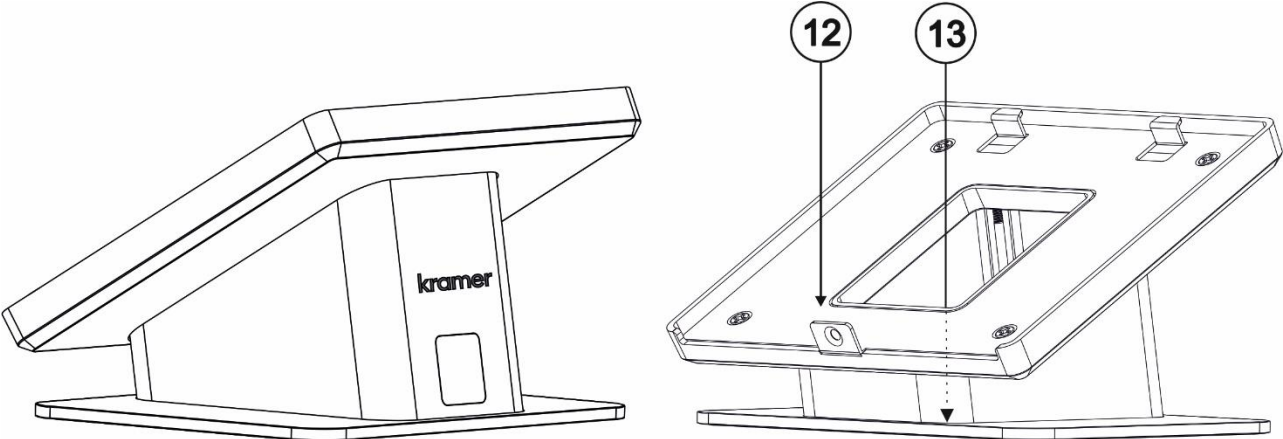

Figure 2: Tabletop Mount Front View

#	Feature	Function
12	Screw Opening	For securing the 8" Touch Panel to the tabletop mount using the supplied M2.5 screw.
13	2 x 5/32" Screw Opening	Optional: For safely securing the tabletop mount to the table from underneath.

KT-208WM On-Wall Mount

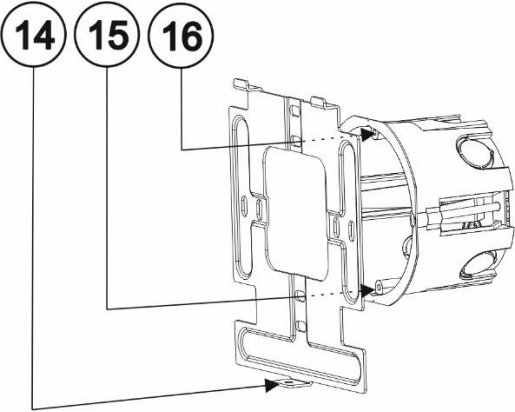



Figure 3: On Wall Mount

#	Feature	Function
14	Screw Opening	For securing the 8" Touch Panel to the wall mount bracket using the supplied M2.5 screw.
15	M3.2 Screw Opening	For securing the wall mount bracket to the gang box.
16	M3.2 Screw Opening	For securing the wall mount bracket to the gang box.

Mounting the KT-208 / KT-208WM

The **KT-208** package is for mounting the touch panel on a table and the **KT-208WM** package is for mounting the touch panel on a wall.

 Always be careful when attaching or removing the **8" Touch Panel** from a mount.

Mounting KT-208 on a Table

Mount **KT-208** on a table using one of the following options:

- **Moveable Mount:** Place the tabletop mount on the table. Connected cables remain visible and the table remains intact.
- **Secure Mount:** Bolt the tabletop mount into the table. Connected cables are hidden through a hole in the table.

Moveable Mount

1. Run any cables that connect to the **KT-208** through the center of the table stand (for example the Ethernet cable).
2. Connect the cables to the **KT-208**.
3. Lay the **KT-208** face-down and mount the table stand on it.
4. Insert and fasten the provided M2.5 screw that secures the bottom of the **KT-208** to the table stand.

The table stand and touch panel are now ready for use.

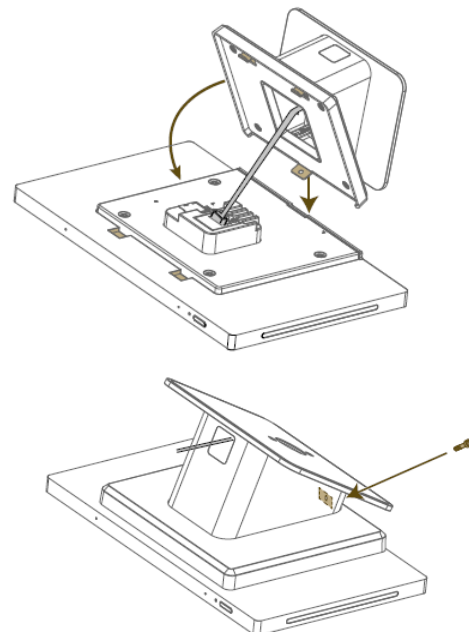

Secure Mount

- You may need to cut an opening in the table, if you need to pass cables from underneath.

1. Secure the stand to the table using the two 5/32" screws provided.

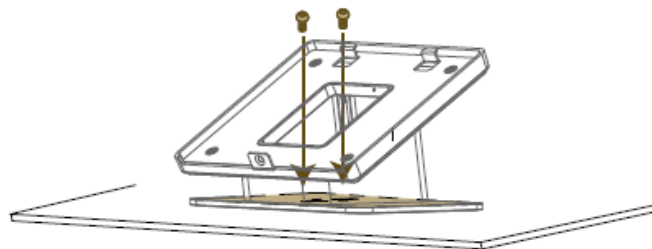

2. Connect any necessary cables to the **KT-208**.

3. Mount the **KT-208** on the stand.

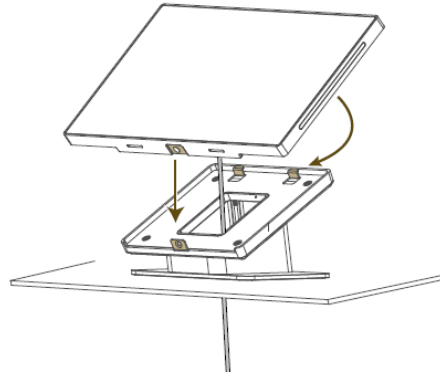

4. Secure the **KT-208** to the stand using the provided M2.5 screw.

The table stand and touch panel are now ready for use.

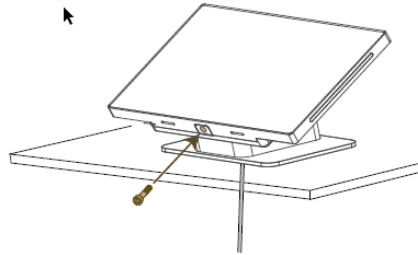

For optimum range and performance use the recommended Kramer cables available at www.kramerav.com/product/KT-208WM. Using third-party cables may cause damage!

Mounting KT-208WM on a Wall

KT-208WM can be safely installed on a wall using a standard 1-Gang in-wall junction box. The cables are passed inside the wall and then connected to the rear side of the on-wall mount unit.

Inserting the On-Wall Mount Unit

To mount the on-wall mount unit

1. Install an in-wall one gang electrical box.
2. Attach the wall mount bracket to the installed gang box (top side up: see the indication arrows on the bracket), using the two M3.2 screws provided.
The wall mount bracket works with UK, EU and US single gang boxes. Screws are provided for all configurations.
3. Connect Ethernet and/or power cables and optionally, insert the micro-USB cable (supplied) for connecting to an adjacent external USB device.

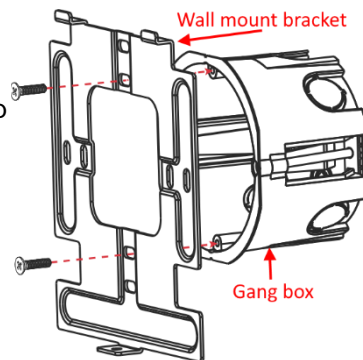

4. Rest **KT-208WM** on the wall mount bracket, snapping the top holders into place and lining up the mounting screw hole at the bottom.

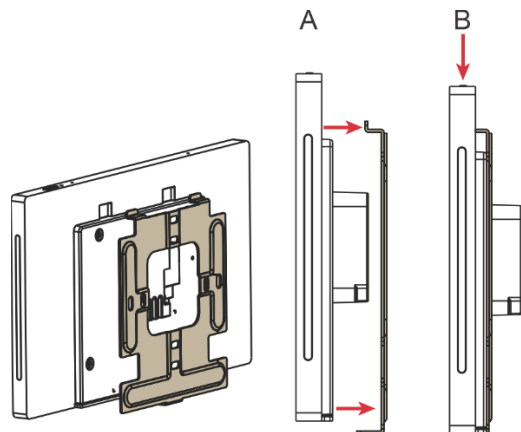

5. Insert the M2.5 screw below the touch panel and secure the touch panel to the wall mount bracket.

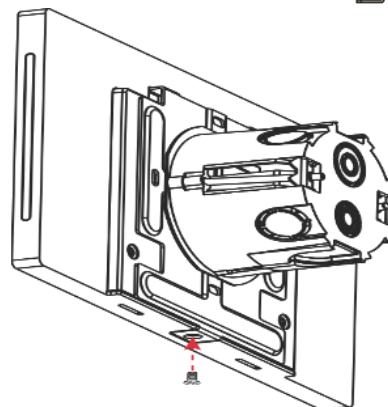

For optimum range and performance use the recommended Kramer cables available at www.kramerav.com/product/KT-208WM. Using third-party cables may cause damage!

Connecting Options

You can power the KT-208 or KT-208WM using any or all of the following options:

1. Connect the PoE-enabled LAN RJ-45 connector to your local area PoE-enabled network.
2. Connect the power adapter to the 12V DC connector on the rear side. The power adapter is optional: It can be purchased separately.

 When both PoE and the power supply are connected to the Touch Panel, the unit is powered by the power supply.

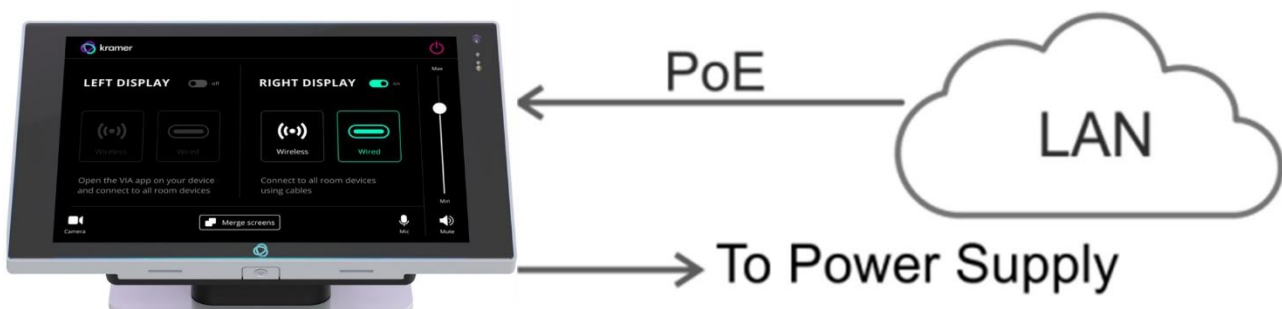

Figure 4: Powering the Touch Panel

Controlling KT-208 / KT-208WM

Using Navigation Buttons or Gestures

By default, **KT-208 / KT-208WM** run the Kramer Control agent and display its login screen at start-up. If available, you can also use the navigation buttons displayed at the bottom of the screen or set up your device to use gesture-based navigation.

Using navigation buttons

Swipe a finger upwards from the line at the bottom of the screen and release to see the navigation buttons:

- ◀ - **Back** – Returns to the previous screen (or opens the home page if there is none).
- - **Home** – Opens the home page, see [Using the Home Page](#) on page 14.
- - **Recent apps** – Scroll between the active apps.

Changing the navigation system

By default, navigation buttons are used, however the touch panel can be set to use gesture navigation instead. To change the navigation method:

1. The touch panel may be set up to run the Kramer Control agent automatically. To exit the Kramer Control agent, enter the PIN (default 9428). If the PIN button is not displayed, swipe up from the Kramer icon at the bottom of the screen to bring up the PIN entry pop-up.
2. On the Home page, press **Settings** . The device's **Settings** menu opens.
3. Select **Advanced settings > System**.
4. In the System menu, press **Gestures** and then **System navigation**.
5. Select **Gesture navigation** or **3-button navigation**. If you are using Gesture navigation, the sensitivity is adjustable.

Using Gesture navigation

- **Back** – Drag a finger inwards from the left or right edge of the screen.
- **Home** – Swipe a finger upwards from the line at the bottom of the screen and release.
- **Recent apps** – Swipe a finger upwards from the line at the bottom of the screen and hold.

Hiding the Navigation Bar

To hide/unhide the navigation bar:

1. On the Home page, press the **Settings** button . The device's **Settings** menu opens.
2. In the Settings menu, open **Player settings** and enable **Fullscreen mode**.

Using the Home Page

Swipe a finger upwards from the line at the bottom of the screen and release to see the navigation buttons:

- - **Home** – Opens the home page.

The Home page contains the following icons:



- Chromium browser



- Touch panel settings



- Kramer Control agent

Exiting or Starting the Kramer Control agent

KT-208 / KT-208WM come with a **Kramer Control agent** (icon ) pre-installed app. The role of this app is to display an interface that you defined in Kramer Control.

When the touch panel starts, the Kramer Control agent runs automatically. To exit the Kramer Control agent, enter the PIN (default 9428). If the PIN button is not displayed, swipe up from the Kramer icon at the bottom of the screen to bring up the PIN entry pop-up.

To re-open the Control Agent click the  icon on the Home page.

During initial installation the k-agent app may need to be started manually the first time.

Basic Settings of KT-208 / KT-208WM

Essential First Steps

To exit the Kramer Control agent, enter the PIN (default 9428). If the PIN button is not displayed, swipe up from the bottom of the screen to bring up the PIN entry pop-up.

To re-open the Control Agent click the  icon on the Home page.

The following are essential first steps in using the touch panel:

1. **Set the device date and time;** [Setting the Date and Time](#) on page [15](#).
2. **Setup the Ethernet and/or Wi-Fi connections;** [Connecting to Wi-Fi or Ethernet](#) on page [16](#).
3. **Consider changing the time that the system checks for firmware (OS) updates;** [Changing the Automated Firmware Update](#) on page [18](#). By default, this is set to midnight, change it if you have no internet access at midnight or prefer another time.
4. **Consider changing the time that the system checks for Kramer Control (APK) updates;** [Changing the Automated Kramer Control update](#) on page [20](#). By default, this is set to midnight, change it if you have no internet access at midnight or prefer another time.
5. **Setup the Kramer Control agent's Launch URL;** See [Using the Kramer Control agent \(connecting to Brain\)](#) on page 22.
6. **Change the display language** (if necessary); [Setting the Display and Keyboard Language](#) on page [21](#).

Setting the Date and Time

The device arrives preset to New York time and you will need to set the correct time region.

To adjust the date and time settings:

1. If necessary, swipe up from the bottom of the screen to bring up the PIN entry pop-up and enter the PIN (default 9428).
2. On the Home page, press the **Settings** button . The device's **Settings** menu opens.
3. Select **Date & Time > Time zone**.
4. Set the correct **Region**. The time will display correctly.

Connecting to Wi-Fi or Ethernet

Connect an Ethernet cable to the device or activate Wi-Fi and setup a connection to your Wi-Fi. If multiple network connections are used, Ethernet will be prioritized over any others.

If you are using 802.1X authentication, do [Installing an 802.1X Certificate](#) on page [17](#), before you connect to the internet.

Connecting Ethernet

Ethernet connections must be plugged into the back of the device, see ⑧ in [Defining KT-208 / KT-208WM 8" Touch Panel](#) on page [7](#). By default, the IP address of the device is set automatically by a DHCP server.

Enabling 802.1X authentication

1. Do [Installing an 802.1X Certificate](#) on page [17](#).
2. In the Settings screen , select **Network & Internet > Ethernet**.
3. Make sure the **Ethernet** is disabled and then enable **Security**.



802.1X authentication cannot be applied to active Ethernet connections

4. Select **802.1X settings** and input the **EAP** (Extensible Authentication Protocol) information.

Using a static IP address

1. If necessary, swipe up from the bottom of the screen to bring up the PIN entry pop-up and enter the PIN (default 9428).
2. From the Home page, open the **Settings** screen .
3. In the Settings screen, select **Network & Internet > Ethernet**.
4. Press **Ethernet IP mode** and select **Static**.
5. Enter the IP information and press **Connect**.

The static IP address is setup.

Connecting Wi-Fi

Enabling 802.1X authentication

1. Do [Installing an 802.1X Certificate](#) on page [17](#).
2. From the Home page, open the **Settings** screen .
3. In the Settings screen, select **Network & Internet > Wi-Fi**.
4. Make sure **Use Wi-Fi** is enabled. The device will scan and list the Wi-Fi networks.
5. Select a Wi-Fi SSID, check **Advanced options** and enter the Wi-Fi information in the fields that appear, then press **Connect**.
6. If you are using 802.1X authentication, then add the certificate information.

802.1X is enabled.

Installing an 802.1X Certificate

802.1X certificates enhance the security of network authentication. **KT-208 / KT-208WM** support .pem, .pfx and .p12 certificate formats.

Installing a certificate is a two-stage process: First import the certificate and then set it up.

Importing an 802.1X certificate

1. Copy the certificate file to an empty USB flash drive.
2. If necessary, swipe up from the bottom of the screen to bring up the PIN entry pop-up and enter the PIN (default 9428).
3. From the Home page, open the **Settings** screen .
4. Select **Advanced settings > Security > Encryption & credentials**.

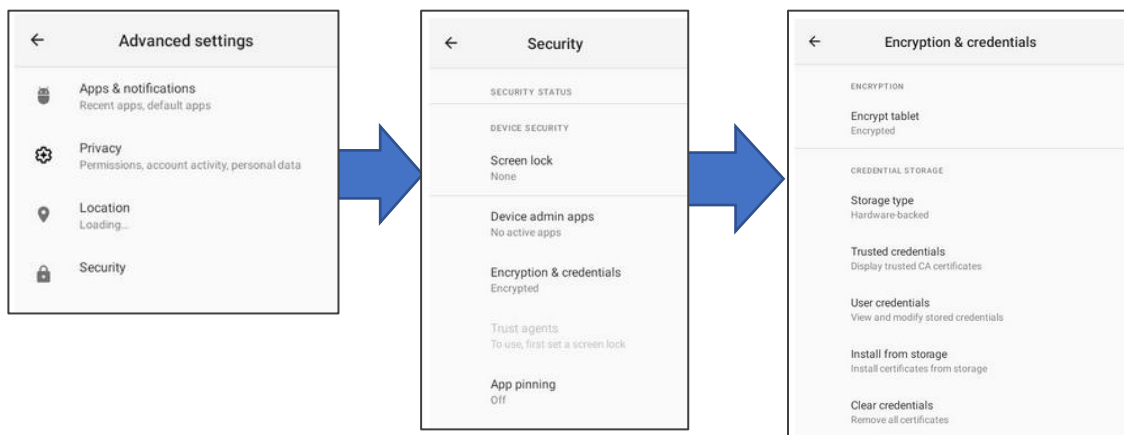



Figure 5: The path to Install from storage

5. In the Encryption & credentials screen, select **Install from storage**: The **Install a certificate** screen opens.
6. Select the **Wi-Fi certificate**: The **Recent** files screen opens. To browse to the file location, press the 3 lines  at the top left of the screen.
7. Select the credentials file and install it, some certificates require you to know a password.

Setting up an 802.1X certificate

8. In the Settings screen, select **Network & Internet > Wi-Fi**.
9. Select **Install from storage**: The **Install a certificate** screen opens.
10. Select **Wi-Fi certificate** (also for Ethernet connections): The **Recent** files screen opens. To browse to the file location, press the 3 lines  at the top left of the screen.

After installing the certificates, see [Connecting to Wi-Fi or Ethernet](#) on page [16](#) for instructions on using the certificates. Ethernet must be disabled before setting-up Ethernet certificates.

Changing the Automated Firmware Update

KT-208 / KT-208WM arrive preset to check for firmware (touch panel OS) updates at midnight every day. If an update is found, the device will download the update file and install it. If you prefer to run manual updates, you must manually download the update file and then install it in the touch panel.

Changing the time of the automated firmware check

1. If necessary, swipe up from the bottom of the screen to bring up the PIN entry pop-up and enter the PIN (default 9428).
2. From the Home page, open the **Settings** screen .
3. Select **Firmware update** and then select **Remote firmware upgrade URL**.

Remote firmware upgrade URL is the site from which the firmware is downloaded.

The upgrade URL (case sensitive):

<https://cdn.kramerav.com/web/apk/transformer-Kramer-AndroidR.xml>



Figure 6: The Firmware update page

4. A pop-up opens, inviting you to set the check time:

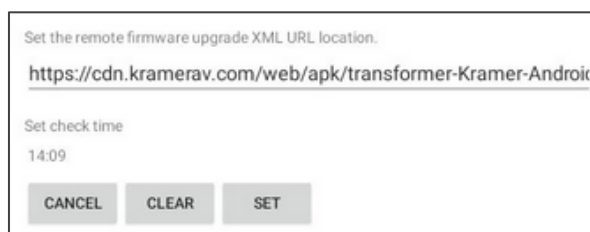

Figure 7: The Remote firmware upgrade URL page

5. To change the time that the system checks for updates, press **Set check time** and select a new time.
6. Press **OK** to close the window and then press **SET**.



Changing (or clearing) the URL will disable the updates.

Manually updating the firmware

Manual firmware updates require a downloaded firmware file from Kramer.

The firmware upgrade process requires:

- An empty USB flash drive to store the firmware file.
- A micro-USB OTG (on the go) cable to connect the USB flash drive to the touch panel.
- Access to the back of the touch panel.

You may need to remove the touch panel from its mount for this purpose. The touch panel should remain connected to a power source such as PoE or the optional power adapter (see ⑧ in [Defining KT-208 / KT-208WM 8" Touch Panel](#) on page 7).

To upgrade the firmware

1. Download the firmware update file from the Kramer website at https://www.kramerav.com/product/KT-208#Tab_Resources.
 - Verify that you are using the correct **KT-208 / KT-208WM** firmware file as there maybe more than one firmware file available.
 - Do not unzip the firmware update file.
2. Copy the firmware file to an empty USB flash drive.
3. If necessary, swipe up from the bottom of the screen to bring up the PIN entry pop-up and enter the PIN (default 9428).
4. On the touch panel, open the **Settings** screen .
5. Select **Firmware update** and then select **Firmware update** (again).
6. Plug the USB flash drive into a micro-USB OTG cable and connect the cable to the back of the touch panel.
7. Click **START FIRMWARE UPDATE**.

The firmware update will then begin.

Changing the Automated Kramer Control update

KT-208 / KT-208WM arrive preset to check for Kramer APK (Android Application Package) updates at midnight every day. If an update is found, the device will download the update file and install it.

Changing the time of the automated APK update check

1. If necessary, swipe up from the bottom of the screen to bring up the PIN entry pop-up and enter the PIN (default 9428).

2. From the Home page, open the **Settings** screen .

3. Select **Remote APP upgrade URL**.

Remote APP upgrade URL is the site from which the APK is downloaded.

The upgrade URL (case sensitive) is:

https://cdn.kramerav.com/web/apk/remote_app_update.xml

4. A pop-up opens, inviting you to set the check time:

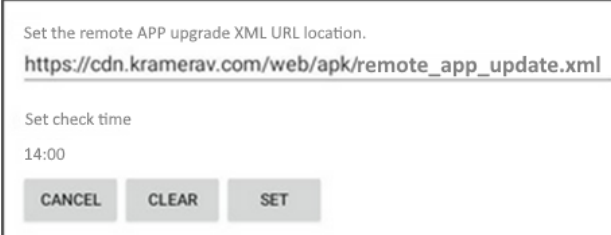

Set the remote APP upgrade XML URL location.
https://cdn.kramerav.com/web/apk/remote_app_update.xml

Set check time
14:00

CANCEL CLEAR SET

Figure 8: The Remote APP upgrade URL page

5. Press **Set check time** to select a new time.
6. Press **OK** to close the window and then press **SET**.



Changing (or clearing) the URL will disable the updates.

Setting the Display and Keyboard Language

To set your preferred interface language:

1. If necessary, swipe up from the bottom of the screen to bring up the PIN entry pop-up and enter the PIN (default 9428).
2. From the Home page, open the **Settings** screen .
3. Select **Language & input**.
4. Press **Add a language** to select a language.
5. If you are using multiple languages, the order in which they are listed represents the priority assigned to them, change the order by dragging languages.
6. Press **On-screen keyboard** to select keyboard languages.

The keyboard language has been set.

Using the Kramer Control agent (connecting to Brain)

The KT-208 / KT-208WM touch panel contains a **Kramer Control agent** (an app), that downloads and displays a user-designed customized interface from **Kramer Control Brain**. The customized interface can control all aspects of the meeting space. For more information about **Kramer Brain**, see www.kramerav.com/product/KT-208.

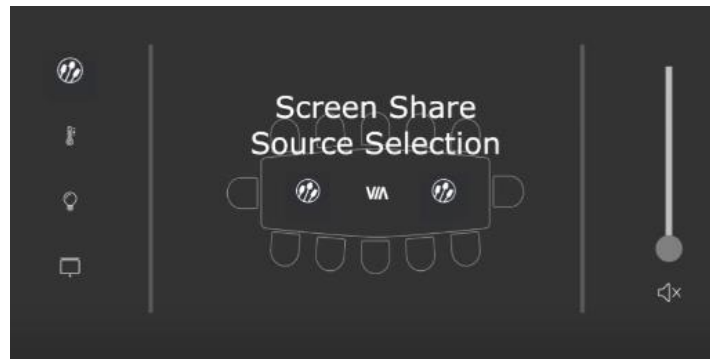

Figure 9: Example of a touch panel interface menu

When the touch panel starts, the **Kramer Control agent** runs automatically (it is pre-installed on KT-208 / KT-208WM). If an interface has been defined, it will be displayed. If not, it will display the Kramer Agent welcome screen where you can enter the interface's IP.

Entering the Control Interface IP & Port Number

On the first run, the Kramer Control app requests the IP & port number of the customized Brain interface to be displayed. The hardware section of the builder's Brain Info contains the URL (in the format IP:port#) of the customized Brain interface. If more than one interface is defined in the Brain, the Brain's IP and port must be followed by two parameters: `/?Interface=<interface ID>&page=<page ID>`. See also [Methods of Setting the Control Interface IP](#) on page 27.

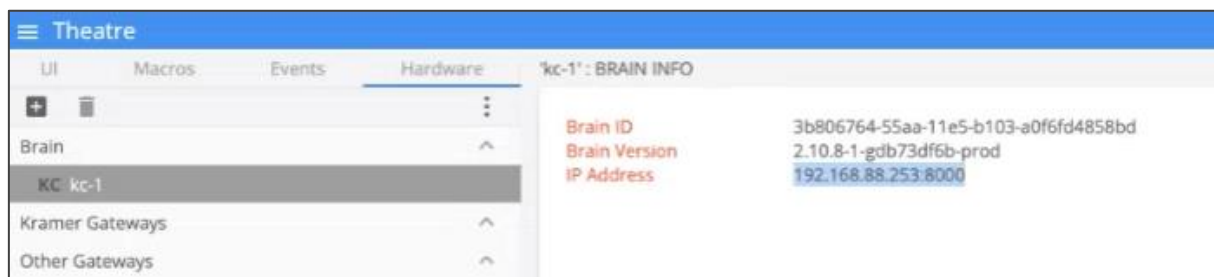

Figure 10: Interface IP Address

Kramer Control Brain port numbers

The IP and port number (and a code on SL-240 / SL-280) are entered in the format IP:port#.

1. **Kramer SL-240 or SL-280:** Port 8000.
2. **KC-Virtual Brain 1:** Port 8001.
3. **KC-Virtual Brain 5:** Ports 8001 – 8005 (KC-Virtual Brain 5 can define up to 5 different touch pad control interfaces, each will use a different port).

The Kramer Control Agent Settings

By default, the Kramer Agent's Welcome screen (Settings) appears the first time the touch panel runs.



To open the Settings:

Slide your finger from the top to the bottom of the screen or vice versa.

The Kramer Agent has 3 settings:

1. Control Interface
2. Display Policy
3. Lock Tablet

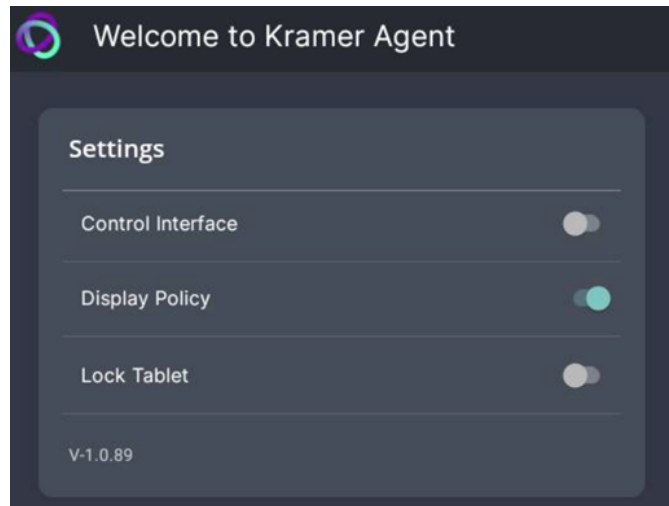

Figure 11: Kramer Agent Welcome screen

- Press each setting to see more options (described below).
- Use the sliders to enable/disable a setting.
- These settings can also be set by API calls. See [Using the Kramer Agent's API on page 25](#).

1. Control Interface

Press **Control Interface** to set the interface IP and Immersive mode.

- **Control Interface** (slider)
After entering the IP of the Control Interface, move the slider to activate the interface and exit the pop-up.

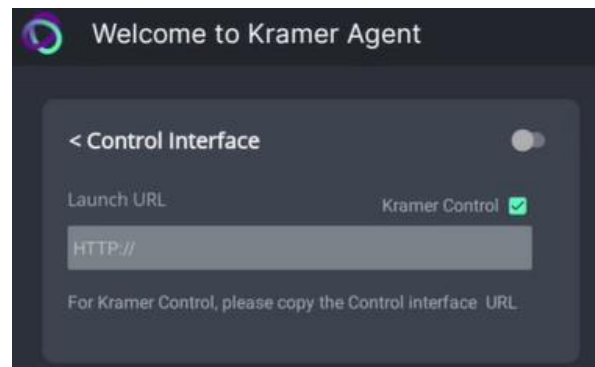

Figure 12: Control Interface options

- **Launch URL**
Enter the IP of the Control Interface or a webpage URL you want displayed on the touch panel. For more options see [Methods of Setting the Control Interface IP](#) on page 27.
- **Kramer Control** (check box)
By default, the Kramer Control box is checked, setting the tablet in **Immersive Mode**: In Immersive (full screen) mode, the system bars are hidden, and users must swipe up/down and enter a PIN to exit the Control Interface. If you are using a generic webpage (such as www.google.com), Immersive mode must be disabled.

2. Display Policy

Press **Display Policy** to view more options.

- **Display Policy** (slider)
Move the slider to activate the policy.
- **Set Default Brightness Level**
This is the % of maximum brightness that the touch panel will return to when the display is re-activated.

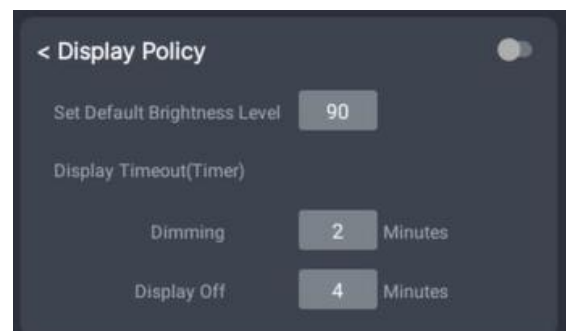

Figure 13: Display Policy options

- **Display Timeout (Timer)**
Dimming – The minutes of inactivity, before dimming to 20% of maximum brightness.
Display Off – The minutes of inactivity, before switching off the display (must be longer than the dimming timeout).

3. Lock Tablet (and USB)

Enable/disable the PIN that restricts access to the Kramer Control agent and USB.
Press **Lock Tablet** to change the PIN and view more options. USB locking is optional.

- **Lock Tablet (slider)**
Move the slider to activate the locking policy defined below.
- **PIN to Unlock screen**
9428 is the default value.
Enter a new PIN to change the value.
- **USB Lock** – Check this box for the tablet lock policy to also disable the tablet's USB port.

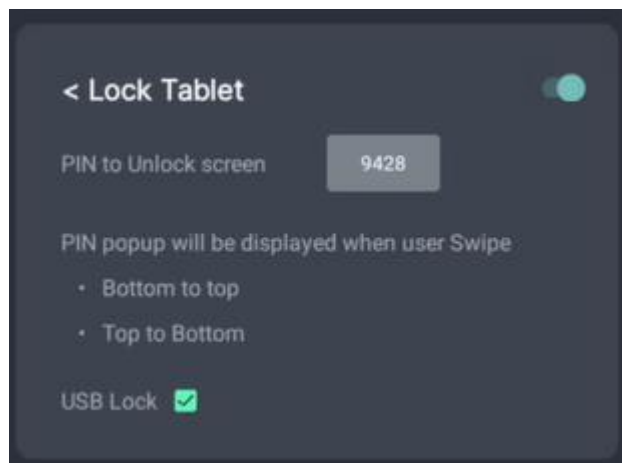

Figure 14: Lock Tablet options

Using the Kramer Control Agent's API

The API changes Kramer Control agent settings remotely, without using the touch panel.



Note:

- The touch panel must be switched on and connected to the same LAN.
- If more than one interface is defined in the Brain, the Brain's IP and port must be followed by two parameters: `/?Interface=<interface ID>&page=<page ID>`. See example 2 below.

Example: Setting the Launch URL in the Control Agent

- Open a browser window on a computer connected to the same network as the touch panel.
- Example: To set the Launch URL in the Kramer Control agent (on the touch panel), use the following format:

`https://<IP of the touch panel>:9804/launchkramerurl?<IP of the brain interface>:<port #>`

Example 1 (single interface defined in Brain):

If the touch panel IP is "192.168.0.56" and the Brain interface IP is "192.168.22.53:8001", enter **`https://192.168.0.56:9804/launchkramerurl?192.168.22.53:8001`**

Example 2 (multiple interfaces defined in Brain):

The URL must include the full interface ID and page. Touch panel IP is "192.168.0.56" and the Brain interface IP is "192.168.2.53:8001/?interface=e84f5fb8-c5a3-4675-9006-d79d3e6cfe59&page=5913c07a-9a41-4fac-9870-e87b1ef719df".

Enter

`https://192.168.0.56:9804/launchkramerurl?192.168.2.53:8001/?interface=e84f5fb8-c5a3-4675-9006-d79d3e6cfe59&page=5913c07a-9a41-4fac-9870-e87b1ef719df`

Note: Use port 9803 if the touch panel uses http and port 9804 if it uses https.

After this command is sent, the touch panel will display the Brain-defined interface.

See the next page for a full list of API commands.

The following API commands can be sent to the touch panel from a browser:

Function	Command structure	Status response (in browser)
Check if the Control agent is running	<code>https://<IP of the touch panel>:9804/health/</code>	"up"
Reboot the touch panel	<code>https://<IP of the touch panel>:9804/reboot/</code>	"Rebooting"
Pause the Control Interface and return to k-agent settings	<code>https://<IP...>:9804/pauselaunchautourl/</code>	"URL launched is paused, Move to Main View"
Resume the Control Interface	<code>https://<IP...>:9804/resumelaunchautourl/</code>	"URL launched is resumed"
Clear the Control Interface's URL setting	<code>https://<IP...>:9804/reseturl/</code>	"URL is reset now"
Set the Control Interface URL (immersive mode). *	<code>https://<IP...>:9804/launchkramerurl?<IP of the interface>:<port#></code>	"Browser will be launched with given URL."
Define a generic URL (touch panel display a non-Brain URL such as www.google.com)	<code>https://<IP...>:9804/launchurl?<full generic URL></code>	"Browser will be launched with given URL."
Enable/disable display control	<code>https://<IP...>:9804/displaysettingon</code> (or <code>displaysettingoff</code>)	
Set the timeout to turn off the display after 4 minutes inactivity	<code>https://<IP...>:9804/setdisplayofftimevalue=4</code>	
Set the timeout to dim the display after 2 minutes inactivity	<code>https://<IP...>:9804/setdisplaydimtime=2</code>	
Set the display brightness in %	<code>https://<IP...>:9804/setdisplaybrightnessvalue=100</code>	

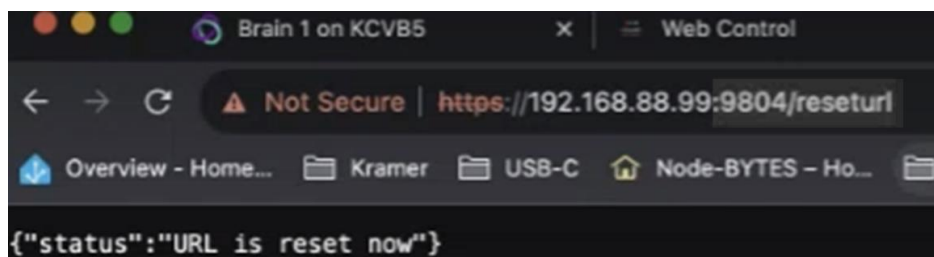

Figure 15: Example of a successful response message.

*If more than one interface is defined in the Brain, the Brain's IP and port must be followed by two parameters: `/?Interface=<interface ID>&page=<page ID>`.

For example:

`https://192.168.0.56:9804/launchkramerurl?192.168.2.53:8001/?interface=e84f5fb8-c5a3-4675-9006-d79d3e6cfe59&page=5913c07a-9a41-4fac-9870-e87b1ef719df`

Methods of Setting the Control Interface URL

When the touch panel starts, the (pre-installed) **Kramer Control agent** runs automatically. You will need to set up its connection with the Kramer Brain, so that it can display the desired control interface.

There are 3 possible methods of setting the interface IP in the Kramer Control agent:

1. In the **Kramer Control agent** (on the touch panel screen).
2. **Using the API** (on a remote computer connected to the same network).
3. In the **Brain software** (setting up the touch panel in the Brain software).

Any one of these methods can load the interface URL into the touch panel's Kramer Control agent.

1. Entering the interface IP in the Kramer Control agent

- a. Kramer Control agent opens automatically when the touch panel starts.
If no interface IP has been entered, the Kramer Agent's **Welcome** screen is displayed:

- If the touch panel is not displaying the Welcome screen, open the **Kramer Agent** app  from the touch panel's Home page and it will be displayed.

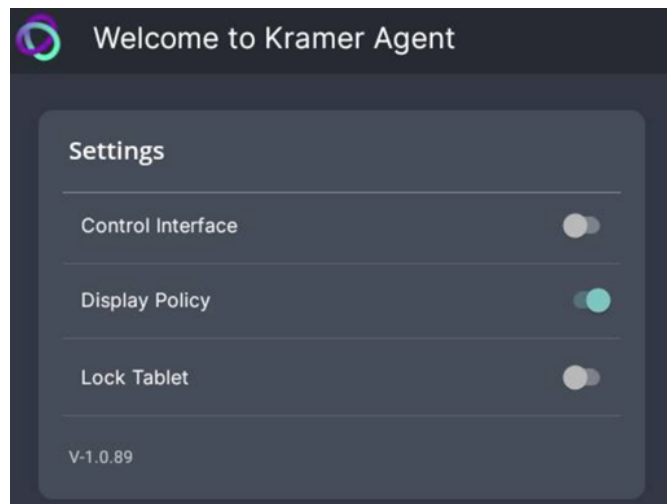

Figure 16: The Kramer Agent Welcome screen

- b. Press **Control Interface**; the **Launch URL** pop-up appears.

- c. Enter the IP address and port of the interface that was defined in Kramer Brain, for example <https://192.168.88.180:8001>.

If more than one interface is defined in the Brain, the Brain's IP and port must be followed by two parameters:
/?Interface=<interface ID>&page=<page ID>.

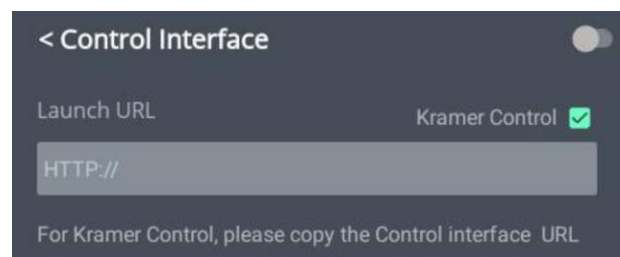

Figure 17: The Launch URL pop-up

See also [Finding the Control Interface IP on page 22](#) and [Example of Setting the Launch URL on page 25](#).

- d. By default, the **Kramer Control** box is checked, setting the tablet in **Immersive Mode**: In Immersive (full screen) mode, the system bars are hidden, and users can only exit the interface by swiping up and entering a PIN. Immersive mode is recommended for the Kramer Control interface; Disable it if you are using a generic webpage (such as www.google.com).
- e. Press OK and the touch panel will load your interface.
- f. To exit the Control Interface and access touch panel controls, slide your fingers up from the bottom of the screen and enter the PIN (default 9428).

2. Controlling the Kramer Control agent by API call

This method of changing settings of the Kramer Control interface can be done remotely, without using the touch panel.

For more information see [Using the Kramer Control Agent's API](#) on page 25.

Note: The touch panel must be switched on and connected to the same LAN.

- a) Open a browser window on a computer connected to the same network as the touch panel.
- b) To set the IP of the Control Interface displayed by the Call the touch panel in the following format:

https://<IP of the touch panel>:9804/launchkramerurl?<IP of the brain interface>:<port #>

- **Example 1** (single interface defined in Brain):
If the touch panel IP is "192.168.0.56" and the Brain interface IP is "192.168.22.53:8001", enter **https://192.168.0.56:9804/launchkramerurl?192.168.22.53:8001**
- **Example 2** (multiple interfaces defined in Brain):
The URL must include the full interface ID and page. Touch panel IP is "192.168.0.56" and the Brain interface IP is "192.168.2.53:8001/?interface=e84f5fb8-c5a3-4675-9006-d79d3e6cfe59&page=5913c07a-9a41-4fac-9870-e87b1ef719df".
Enter
https://192.168.0.56:9804/launchkramerurl?192.168.2.53:8001/?interface=e84f5fb8-c5a3-4675-9006-d79d3e6cfe59&page=5913c07a-9a41-4fac-9870-e87b1ef719df

After this command is sent, the touch pad will display the Brain-defined interface and a status response message returned to the sender.

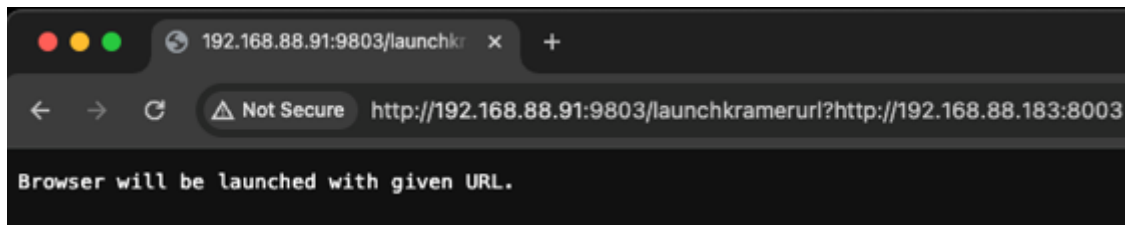

Figure 18: Example of a successful response message.

3. Setup the touch panel in the Brain Builder

The advantage of this method is that future changes to the interface are automatically uploaded to the tablet.

The following assumes that:

- a) The interface is already setup in the Brain.
- b) The touch panel is active and connected to the same network as the Brain.
- c) The IP of the touch panel is static and DHCP assigned.

1. Preliminary Setup: In the **Devices** tab of the Builder screen, add the **K-Agent** driver as a device. It must be assigned to the same network gateway as the touch panel.
2. Navigate to the Brain control page on your computer.
3. Select the interface that you want to use on the touch panel.
4. Copy the interface's URL from the address bar (see the image below).

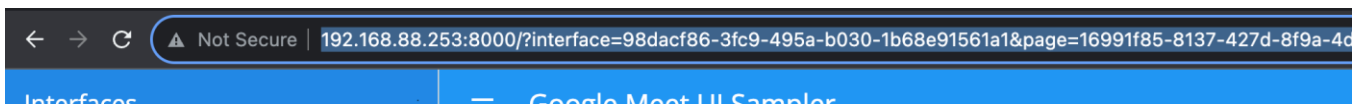

5. Navigate back to the Builder, double click on the touch panel (in the **Devices** list) and paste the URL from the previous step to the **Kramer Control URL**. Assign it a **Friendly Name**.

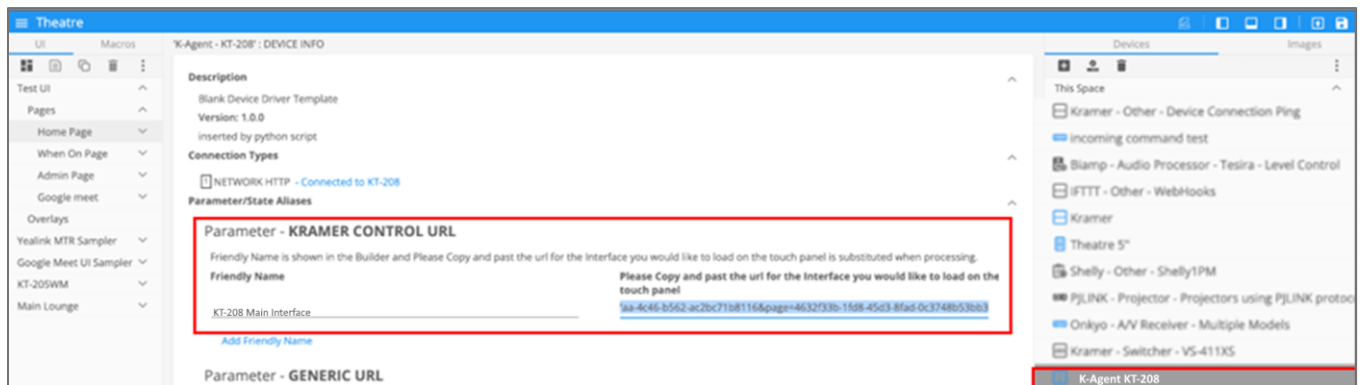

Figure 19: Kramer Control URL in the Builder

6. For the Brain to be able to automatically assign the user interface to the touch panel: (see the image on the next page)
 - a) In the **Events** tab, click **System Events** and select "Initialization".
 - b) Drag the **Launch Kramer URL** command to the 'Initialization' ACTIONS area.
 - c) Select the **Friendly Name** (If only one interface is defined, it will be used by default).

The screenshot displays the Theatre control interface. The main window is titled 'Theatre' and shows the 'Events' configuration for 'Initialization'. The event is triggered when the Brain enters the active stage. The actions include:

- Command: Query Volume Level on Onkyo - A/V Receiver - Multiple Models
 - VOLUME ZONE = Main Zone
- Command: Query Mute on Onkyo - A/V Receiver - Multiple Models
 - MUTE ZONE = Main Zone
- Command: Query Power State on Onkyo - A/V Receiver - Multiple Models
 - POWER ZONE = Main Zone
- Command: Launch Kramer URL on K-Agent - KT-208 (highlighted with a red arrow)
- Delay: 10 seconds

The right sidebar shows the 'Devices' list with 'K-Agent - KT-208' selected. The 'Commands' list includes 'Launch Kramer URL'.

PROPERTIES	
Name	Launch Kramer UI
Interfaces Supported	HTTP
Dynamic Parameters	None
Static Parameters	None

Figure 20: System Events window open on Initialization actions

7. Every time the Brain reboots or connects to the touch panel the interface will be updated.

Advanced Settings

Scheduling a Daily Reboot

A daily reboot is recommended to improve product performance and stability. The daily reboot option causes the device to reset itself every day at the set time (or within 30 minutes of the set time if it is in use).

1. If the screen is locked, swipe up from the bottom to bring up the PIN entry pop-up and enter the PIN (default 9428).
2. From the Home page, open the **Settings** screen .
3. Select **Schedule Reboot** and set the reboot time.
4. Enable **Optimize Server Performance** to have the device reboot at a random time within 30 minutes of the scheduled time. If you are using multiple devices, then this prevents them from all rebooting at the same time.

The daily reboot is complete.

Password Protecting Device Settings

Device settings can be protected with a password to prevent users from making any changes.

1. If the screen is locked, swipe up from the bottom to bring up the PIN entry pop-up and enter the PIN (default 9428).
2. From the Home page, open the **Settings** screen .
3. Select **Security Password** to enable and enter the password.

Factory Reset & Reboot

The **Settings > Reset** options menu enables you to perform a factory reset or to reboot the device, reset Wi-Fi or Bluetooth or reset app preferences.

To reset to factory settings

1. If the screen is locked, swipe up from the bottom to bring up the PIN entry pop-up and enter the PIN (default 9428).
2. From the Home page, open the **Settings** screen .
3. Select **Erase all data (factory reset)**.

Other options available: Reboot device, Reset Wi-Fi, mobile & Bluetooth and Reset app preferences.

Resetting with the external reset button

Insert a pin into the pinhole on the back  (see [Defining KT-208 / KT-208WM 8" Touch Panel](#) on page 7) and hold for 22 seconds to reset the device to factory default values.

A second pinhole on the top,  can be used to restart the device by inserting a pin for a few seconds.

Logging Activity

By default, the device does not log activity. Logging can be useful for debugging or monitoring use.

Activating logging

1. If the screen is locked, swipe up from the bottom to bring up the PIN entry pop-up and enter the PIN (default 9428).
2. From the Home page, open the **Settings** screen .
3. Select **Log** and set the **Log Location**.

Logging is activated.

Accessing an internally stored log file

A USB flash drive and OTG cable are required to copy an internally stored log file:

1. In the root directory of the flash drive, create a folder called “**_dump_debug_log**”.
2. Connect the OTG cable to the micro-USB connection on the back of the device.
3. Connect the flash drive to the OTG cable.
4. The device will automatically download the log file to the USB device and issue a confirmation message “**Saved log file to USB storage**”.

The log is accessed.

Modifying Display Settings

The screen orientation can be customized, and the navigation bar can be hidden.

Changing the screen orientation

1. If the screen is locked, swipe up from the bottom to bring up the PIN entry pop-up and enter the PIN (default 9428).
2. From the Home page, open the **Settings** screen .
3. Select Display and then press Screen Orientation.

Choose between 0 degrees (default), 90 degrees, 180 degrees and 270 degrees.

Hiding the navigation bar

1. If the screen is locked, swipe up from the bottom to bring up the PIN entry pop-up and enter the PIN (default 9428).
2. From the Home page, open the **Settings** screen .
3. In the Settings menu, open **Player settings** and enable **Fullscreen mode**.

The Navigation bar is no longer accessible.

Defining an auto-start playlist

The device can be set to automatically play the contents of a predefined folder. The folder can be internally defined or read from a flash device connected to the micro USB port or a Micro SD card inserted into the card reader (see [Defining KT-208 / KT-208WM 8" Touch Panel](#) on page 7).

To setup a playlist:

1. Load the media you want to play onto an SD card or USB flash drive. Play order is set by the alphabetic order of the item's names.
2. Connect the drive or card (for a flash drive connect an OTG cable to the micro-USB drive).
3. If the screen is locked, swipe up from the bottom to bring up the PIN entry pop-up and enter the PIN (default 9428).
4. On the touch panel, open the **Settings** screen .
5. Select Player Settings and then select Instant Play.
6. Enable **Instant play**. If you check **Copy and play as internal storage**, the device will load the (external) folder contents into internal storage.
7. Press SELECT FOLDER.
8. If you copied external content to internal storage, then you can remove the external device.

The Content field in the Home page will be changed to the storage location of your content.



The home page's Content field defines the auto-start link to Kramer Control.

Changing the value in this field is not recommended as it will disable Kramer Control.

Defining auto-start HTML or SMIL content

The device home page can be set to automatically run an HTML page or SMIL content.

1. Place your HTML content in a folder called HTML in the root of an SD card or flash drive and attach them to the device (for a flash drive use an OTG cable connected to the micro USB drive).
2. When the USB drive is connected to the device, an automatic pop-up message will notify you that the copy is about to start.

The Content field in the Home page will be changed to the storage location of your content.



The home page's Content field defines the auto-start link to Kramer Control.

Changing the value in this field is not recommended as it will disable Kramer Control.

Switching to Native Android Mode

Switching to native Android mode turns the device into a regular android device, allowing you full control of its content.



Changing to native Android will disable Kramer Control.

To make the switch:

1. If the screen is locked, swipe up from the bottom to bring up the PIN entry pop-up and enter the PIN (default 9428).
2. From the Home page, open the **Settings** screen .
3. Select Player Settings and then press Native Android Mode.



Figure 21: The Player settings page

Native Android mode is restored.

Technical Specifications

Ports	1 Micro USB	On a female USB type C (ADB) connector
	1 Ethernet	On an RJ-45 female connector, 10/100/1000M with PoE 802.3at
Platform	Operating System CPU	Android Version 11 ARM Quad Core Cortex-A53 up to 1.8Ghz (64 bit)
Memory	RAM	LPDDR4 4GB
	Internal	32GB eMMC (flash)
Display	Touch Panel Type	10.1 point capacitive multi-touch
	Size	8"
	Resolution	1280x720 RGB pixels, 16:10 aspect ratio, 350cd/m2 brightness, 1000:1 contrast ratio
Wireless Connectivity	Wi-Fi	Wi-Fi 6, 802.11 a/b/g/n/ax/ax
	Bluetooth	BT 5.0
Video	Camera	5MP FF
	Video Formats	H.264, H.265, VC-1, MPEG-4, VP8, VP9
	Image Codecs	JPEG, BMP, GIF, PNG
Audio	Speakers	2x 1W
	Codecs	MPEG, OGG, AAC
	Microphone	2 built-in.
Power	PoE	44 to 57V DC 0.3A Complies with IEEE802.3af and IEEE802.3at PoE standards
	Optional Power Adapter	12V 2.0 A Note: Operating temperature: 0~40°C
Controls	Function Button	On top
	Reset Button	On top, recessed
	Factory Reset Button	On back, recessed
LED	Side-light	Can indicate room status (requires 3 rd party integration).
Environmental conditions	Operating Temperature	0~40°C (32~104°F)
	Storage Temperature	-20~60°C
	Operating Humidity	5% to 85%
	Storage Humidity	5% to 90%
Regulatory Compliance	Safety	CE, FCC, UL, UKCA
	Environmental	RoHs, WEEE
Dimensions	Touch Panel	212 x 25 x 127mm (W,D,H)
	Touch Panel Stand	131 x 120 x 98mm (max height) KT-208 only (W,D,H).
	Wall Mount	1 gang KT-208WM only.
Weight	Touch Panel	482g
	Tabletop Stand	300g
Shipping carton (4 pcs)	Dimensions (W,D,H)	290 x 206 x 164mm
	Weight	KT-208 : 1.35kg (includes tabletop stand) KT-208WM : 1kg
Accessories	Optional	Power adapter.
	KT-208	Tabletop mount unit.
	KT-208WM	On-wall mount unit and panel mount plate
Specifications are subject to change without notice at www.kramerav.com		

The warranty obligations of Kramer Electronics Inc. ("Kramer Electronics") for this product are limited to the terms set forth below:

What is Covered

This limited warranty covers defects in materials and workmanship in this product.

What is Not Covered

This limited warranty does not cover any damage, deterioration or malfunction resulting from any alteration, modification, improper or unreasonable use or maintenance, misuse, abuse, accident, neglect, exposure to excess moisture, fire, improper packing and shipping (such claims must be presented to the carrier), lightning, power surges, or other acts of nature. This limited warranty does not cover any damage, deterioration or malfunction resulting from the installation or removal of this product from any installation, any unauthorized tampering with this product, any repairs attempted by anyone unauthorized by Kramer Electronics to make such repairs, or any other cause which does not relate directly to a defect in materials and/or workmanship of this product. This limited warranty does not cover cartons, equipment enclosures, cables or accessories used in conjunction with this product.

Without limiting any other exclusion herein, Kramer Electronics does not warrant that the product covered hereby, including, without limitation, the technology and/or integrated circuit(s) included in the product, will not become obsolete or that such items are or will remain compatible with any other product or technology with which the product may be used.

How Long this Coverage Lasts

The standard limited warranty for Kramer products is seven (7) years from the date of original purchase, with the following exceptions:

1. All Kramer VIA hardware products are covered by a standard three (3) year warranty for the VIA hardware and a standard three (3) year warranty for firmware and software updates; all Kramer VIA accessories, adapters, tags, and dongles are covered by a standard one (1) year warranty.
2. Kramer fiber optic cables, adapter-size fiber optic extenders, pluggable optical modules, active cables, cable retractors, ring mounted adapters, portable power chargers, Kramer speakers, and Kramer touch panels are covered by a standard one (1) year warranty. Kramer 7-inch touch panels purchased on or after April 1st, 2020 are covered by a standard two (2) year warranty.
3. All Kramer Calibre products, all Kramer Minicom digital signage products, all HighSecLabs products, all streaming, and all wireless products are covered by a standard three (3) year warranty.
4. All Sierra Video MultiViewers are covered by a standard five (5) year warranty.
5. Sierra switchers & control panels are covered by a standard seven (7) year warranty (excluding power supplies and fans that are covered for three (3) years).
6. K-Touch software is covered by a standard one (1) year warranty for software updates.
7. All Kramer passive cables are covered by a lifetime warranty.

Who is Covered

Only the original purchaser of this product is covered under this limited warranty. This limited warranty is not transferable to subsequent purchasers or owners of this product.

What Kramer Electronics Will Do

Kramer Electronics will, at its sole option, provide one of the following three remedies to whatever extent it shall deem necessary to satisfy a proper claim under this limited warranty:

1. Elect to repair or facilitate the repair of any defective parts within a reasonable period of time, free of any charge for the necessary parts and labor to complete the repair and restore this product to its proper operating condition. Kramer Electronics will also pay the shipping costs necessary to return this product once the repair is complete.
2. Replace this product with a direct replacement or with a similar product deemed by Kramer Electronics to perform substantially the same function as the original product. If a direct or similar replacement product is supplied, the original product's end warranty date remains unchanged and is transferred to the replacement product.
3. Issue a refund of the original purchase price less depreciation to be determined based on the age of the product at the time remedy is sought under this limited warranty.

What Kramer Electronics Will Not Do Under This Limited Warranty

If this product is returned to Kramer Electronics or the authorized dealer from which it was purchased or any other party authorized to repair Kramer Electronics products, this product must be insured during shipment, with the insurance and shipping charges prepaid by you. If this product is returned uninsured, you assume all risks of loss or damage during shipment. Kramer Electronics will not be responsible for any costs related to the removal or re-installation of this product from or into any installation. Kramer Electronics will not be responsible for any costs related to any setting up this product, any adjustment of user controls or any programming required for a specific installation of this product.

How to Obtain a Remedy Under This Limited Warranty

To obtain a remedy under this limited warranty, you must contact either the authorized Kramer Electronics reseller from whom you purchased this product or the Kramer Electronics office nearest you. For a list of authorized Kramer Electronics resellers and/or Kramer Electronics authorized service providers, visit our web site at www.kramerav.com or contact the Kramer Electronics office nearest you.

In order to pursue any remedy under this limited warranty, you must possess an original, dated receipt as proof of purchase from an authorized Kramer Electronics reseller. If this product is returned under this limited warranty, a return authorization number, obtained from Kramer Electronics, will be required (RMA number).

You may also be directed to an authorized reseller or a person authorized by Kramer Electronics to repair the product.

If it is decided that this product should be returned directly to Kramer Electronics, this product should be properly packed, preferably in the original carton, for shipping. Cartons not bearing a return authorization number will be refused.

Limitation of Liability

THE MAXIMUM LIABILITY OF KRAMER ELECTRONICS UNDER THIS LIMITED WARRANTY SHALL NOT EXCEED THE ACTUAL PURCHASE PRICE PAID FOR THE PRODUCT. TO THE MAXIMUM EXTENT PERMITTED BY LAW, KRAMER ELECTRONICS IS NOT RESPONSIBLE FOR DIRECT, SPECIAL, INCIDENTAL OR CONSEQUENTIAL DAMAGES RESULTING FROM ANY BREACH OF WARRANTY OR CONDITION, OR UNDER ANY OTHER LEGAL THEORY. Some countries, districts or states do not allow the exclusion or limitation of relief, special, incidental, consequential or indirect damages, or the limitation of liability to specified amounts, so the above limitations or exclusions may not apply to you.

Exclusive Remedy

TO THE MAXIMUM EXTENT PERMITTED BY LAW, THIS LIMITED WARRANTY AND THE REMEDIES SET FORTH ABOVE ARE EXCLUSIVE AND IN LIEU OF ALL OTHER WARRANTIES, REMEDIES AND CONDITIONS, WHETHER ORAL OR WRITTEN, EXPRESS OR IMPLIED. TO THE MAXIMUM EXTENT PERMITTED BY LAW, KRAMER ELECTRONICS SPECIFICALLY DISCLAIMS ANY AND ALL IMPLIED WARRANTIES, INCLUDING, WITHOUT LIMITATION, WARRANTIES OF MERCHANTABILITY AND FITNESS FOR A PARTICULAR PURPOSE. IF KRAMER ELECTRONICS CANNOT LAWFULLY DISCLAIM OR EXCLUDE IMPLIED WARRANTIES UNDER APPLICABLE LAW, THEN ALL IMPLIED WARRANTIES COVERING THIS PRODUCT, INCLUDING WARRANTIES OF MERCHANTABILITY AND FITNESS FOR A PARTICULAR PURPOSE, SHALL APPLY TO THIS PRODUCT AS PROVIDED UNDER APPLICABLE LAW. IF ANY PRODUCT TO WHICH THIS LIMITED WARRANTY APPLIES IS A "CONSUMER PRODUCT" UNDER THE MAGNUSON-MOSS WARRANTY ACT (15 U.S.C.A. §2301, ET SEQ.) OR OTHER APPLICABLE LAW, THE FOREGOING DISCLAIMER OF IMPLIED WARRANTIES SHALL NOT APPLY TO YOU, AND ALL IMPLIED WARRANTIES ON THIS PRODUCT, INCLUDING WARRANTIES OF MERCHANTABILITY AND FITNESS FOR THE PARTICULAR PURPOSE, SHALL APPLY AS PROVIDED UNDER APPLICABLE LAW.

Other Conditions

This limited warranty gives you specific legal rights, and you may have other rights which vary from country to country or state to state.

This limited warranty is void if (i) the label bearing the serial number of this product has been removed or defaced, (ii) the product is not distributed by Kramer Electronics or (iii) this product is not purchased from an authorized Kramer Electronics reseller. If you are unsure whether a reseller is an authorized Kramer Electronics reseller, visit our web site at www.kramerav.com or contact a Kramer Electronics office from the list at the end of this document.

Your rights under this limited warranty are not diminished if you do not complete and return the product registration form or complete and submit the online product registration form. Kramer Electronics thanks you for purchasing a Kramer Electronics product. We hope it will give you years of satisfaction.



HDMI™
HIGH-DEFINITION MULTIMEDIA INTERFACE



P/N: 2900-301633

Rev: 4



SAFETY WARNING

Disconnect the unit from the power supply before opening and servicing

For the latest information on our products and a list of Kramer distributors, visit our website where updates to this user manual may be found.

We welcome your questions, comments, and feedback.

The terms HDMI, HDMI High-Definition Multimedia Interface, and the HDMI Logo are trademarks or registered trademarks of HDMI Licensing Administrator, Inc. All brand names, product names, and trademarks are the property of their respective owners.